

Concrete Foundation Recommendations for silos 350

General information

All foundation specifications should be construed as recommendations only.

This documentation has been prepared for exemplary conditions for installing the silo. It is necessary to verify the construction documentation by a person holding the building commissions each time, according to new local conditions.

Foundations construction

-Concrete class C20/25, thickness 50cm, reinforced with steel rods class A-IIIN Layer of concrete class C12/15 under plate up to level of freezing ground.

-Layer of heat-weldable roofing membrane, thickness at least 4 mm

-Static calculations which have been prepared regard installation of the plate on the ground with min. capacity of 50 kPs

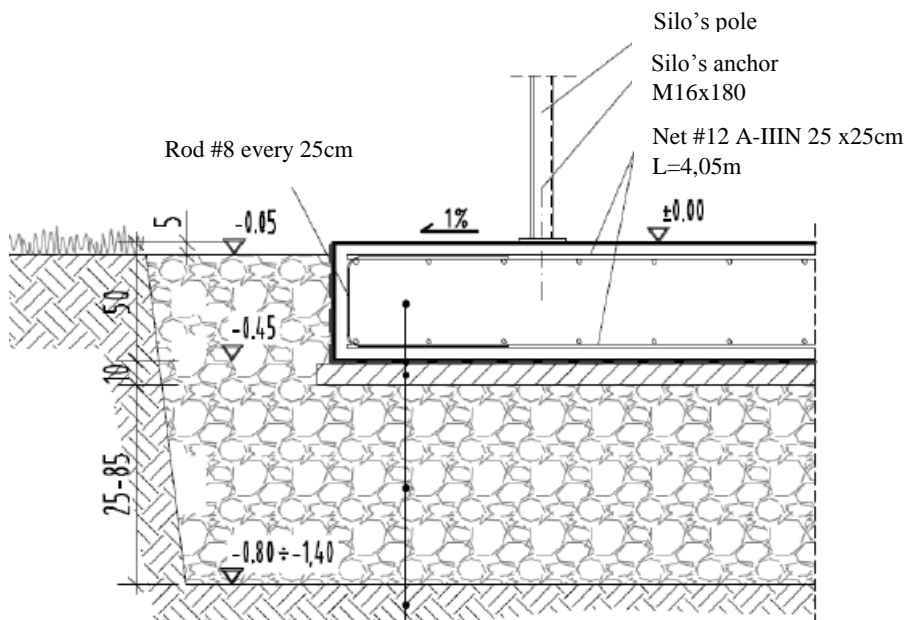

*Foundation plate of thickness 50 cm, concrete C20/25 W8.

*Layer of heat-weldable roofing membrane of thickness at least 4 mm.

*Bedding concrete C12/15, thickness of 10 cm.

*Crushed aggregate, fraction 0-32 mm, volume should be adjusted to the surface conditions.

*Subsoil

NOTICE:

- depth of the installation should be taken according to appropriate zone of freezing the ground
- lagging the rods, $a=5$ cm
- an adaptive building project will determine the way of grounding the silo
- the edges of plate should be protected against breaking down or crushing, through concreting the angle L30x30x2.

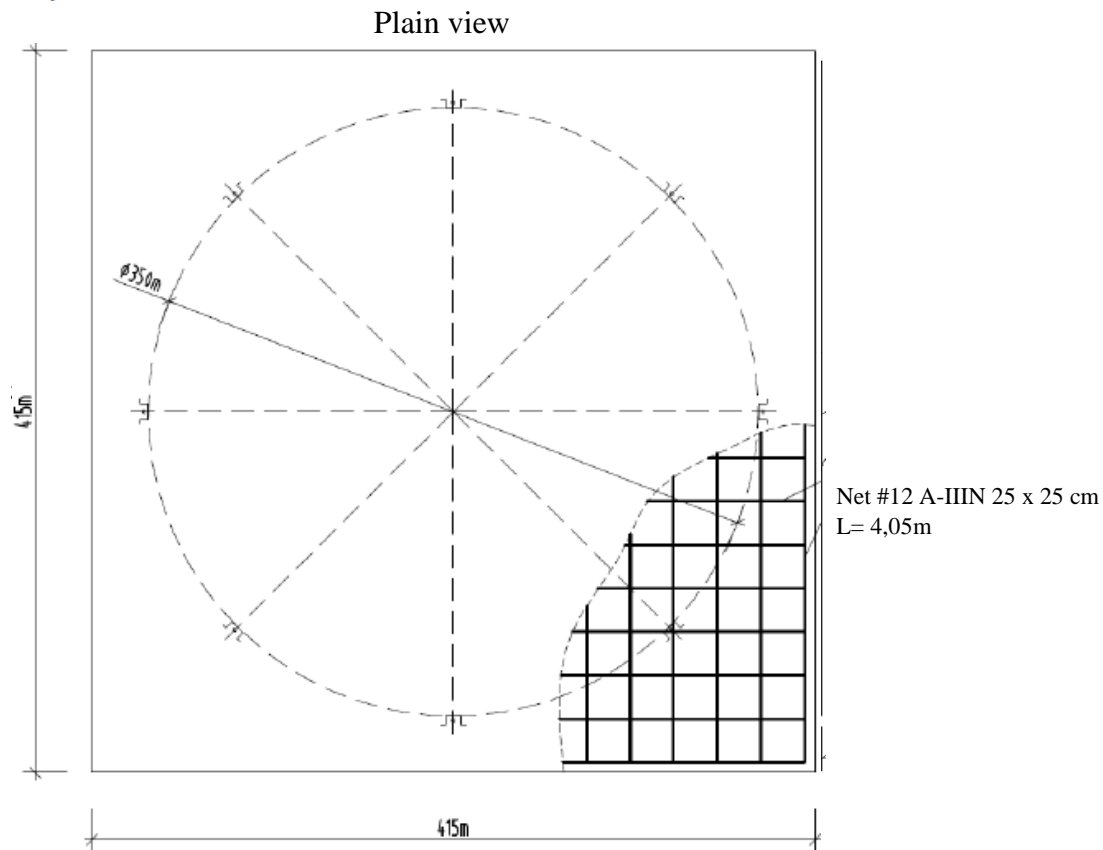

Reinforcement of foundations plate

Detal zabezpieczenia krawędzi płyty fundamentowej

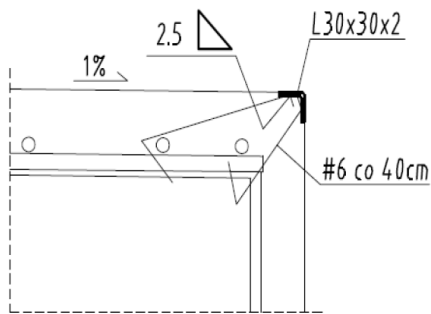

*Main reinforcing in two directions (from top and bottom) with rods #12 each 25/25 cm.

*reinforcement of the edged of plate with the rods #8 40 x diameter of the main reinforcing

INSTALLATION OF THE SILO

*anchoring of the silo only after setting the installation closures.

*clean the drilled closure from the dust, with the compressed air.

*the depth of anchoring should be at least 120 mm

*Fix the anchors through the closures in accordance with the declaration as well as manual from the anchors's producer.

*use the mechanical anchor M16x180 class 5.8

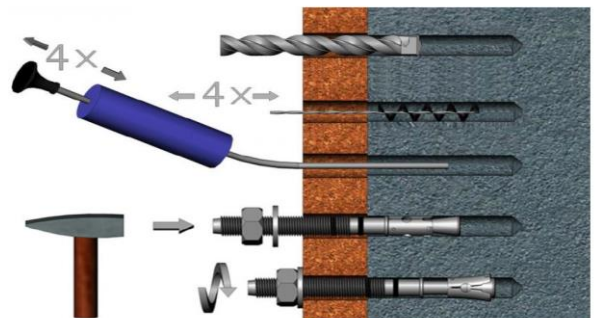

NORMS AND REGULATIONS

Manufacturer declares that above mentioned type of silos holds the CE sign and it complies with latests norms Eurocode and following regulations:

- PN-EN 1993-4-1 Eurocode 3 Designing the steel constructions
- PN-EN 1991-4 and - PN-EN 1991-1-1 Eurocode 1 Implications for constructions
- PN-EN 1991-1-3 Snow load up to IV snow zone
- PN-EN 1991-1-4 Wind load up to II wind zone
- PN-EN ISO 14713-1:2010 Zinc covers
- Ordinance of the Minister of Labour and Social Policy concerning the general regulations on work safety and hygiene Dz.U. Nr 129 poz. 844



POLNET Sp. z o.o. i Wspólnicy Spółka Komandytowa, ul. Sowia 13 B, 62-080 Tarnowo Podgórne, Polska,
tel.: + 48 61 657 67 00, fax: + 48 61 657 67 67, office@polnet.pl, NIP: 621-17-06-651, Sąd Rejonowy Poznań
Nowe Miasto i Wilda w Poznaniu, KRS nr 0000227691; Kapitał Spółki Komandytowej 13.300.000 PLN.

www.polnet.pl